

DİKİLİ TİP YAN KAPAK MONTAJ
WALL MOUNT DOOR TYPE

DIŞ ORTAM KLİMASI
OUTDOOR TYPE COOLING UNIT

PASLANMAZ ÇELİK
STAINLESS STEEL

A SINIFI EKİPMAN
A CLASS EQUIPMENT

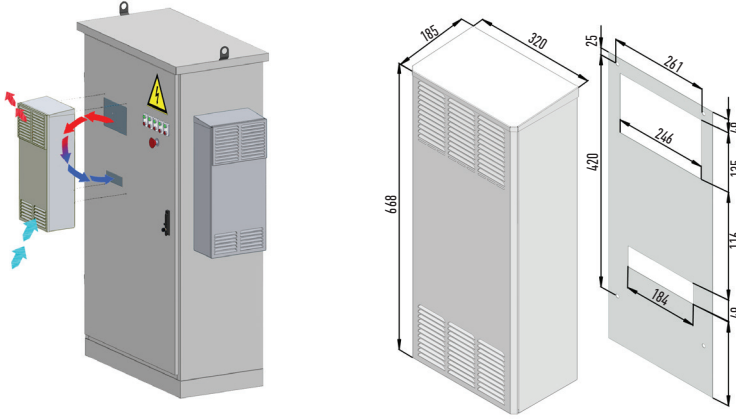

TEKNİK BİLGİLER

TECHNICAL DETAILS

0-500

Soğutma Kapasitesi L35 L35	Cooling Capacity L35 L35	450 W
Soğutucu Gaz Tipi	Type Of Refrigerant	R 134a
Soğutucu Gaz Miktarı	Amount Of Refrigerant	290 gr
Termostat Fabrika Ayarı	Termostat Setting	34 °C
Difransiyel	Hysteresis	4 °C
Dış Ünite Fan Debisi	External Circuit	540 m ³ /h
İç Ünite Fan Debisi	Internal Circuit	290 m ³ /h
Enerji Frekansı	Rated Frequency	50/60 Hz
Standart Güç	Standard Power Supply	198 V...252 V
Çekilen Güç	Power Absorbed L35 L35	312 W
Çalışma Akımı	Running Current	1.6 A
Başlangıç Akımı	Starting Current	5.2 A
Ağırlık	Weight	19 kg
Yükseklik x Genişlik x Derinlik	Height x Width x Depth mm	668 X 320 X 185
Metal Aksam Cinsi	Corrosion Protection (cover)	Stainless
Montaj Şekli	Orientation	Wall Mount
Koruma Sınıfı	System of Protection	IP 65
Çalışma Aralığı	Ambient Air Temperature	0°C +55 °C
Kompresör	Compressor	Danfoss-Secop
Fanlar	Fans	EbmPapst

